

Aluminum 5000R

Partitions • Operable | Vertical Lift | Glasswall | Automatic

The HUFCOR Commitment to Green Manufacturing, Sustainability and LEED™ 赫福高致力於綠色環保事業 並可應用於LEED™的相關認證

HUFCOR is committed to being an industry leader in protecting the environment by reducing pollutants and minimizing our environmental impact on the air, water and land. For more than 10 years we utilized a "Green" approach to our manufacturing techniques and energy consumption, all while increasing the percentage of materials that we recycle, reuse, repair, restock or return for salvage. Today, HUFCOR's commitment and progress toward Green manufacturing is greater than ever as we continue to develop standards that support various LEED™ (Leadership in Energy and Environmental Design) points to assist the achievement of LEED™ certification goals.

赫福高承諾要成為行業中的綠色環保領導者，藉由減少污染及降低對空氣、水與土地的影響來保護環境。赫福高十多年來早已在製造及消耗能源方面採用「綠色」環保方案，且不斷提升回收、再利用、物料循環使用的比例，並持續開發符合各種LEED™ (綠建築認證)的標準。現今的赫福高，對綠色環保製程的承諾與發展早已超越我們過去的紀錄。

 Design & Technology Developed by HUFCOR in the USA
設計及技術來自美國赫福高



HUFCOR Hong Kong - Asia Pacific headquarters
Unit 2501-03 & 05, 25/F The Octagon, 6 Sha Tsui Road, Tsuen Wan, New Territories, Hong Kong
T: (852) 2688 0912 F: (852) 2688 0896 E: hongkong@hufcor.com

All rights reserved. No part of this publication may be reproduced, stored in any retrieval system, or transmitted in any form or by any means, electronic, mechanical, photocopying, recording, or otherwise without the publisher's prior written permission.
保留所有權利。未經出版者事先書面同意，本出版物任何部分均不得複製，不得儲存於任何檢索系統，或以任何形式或方法如電子、書寫、複印、錄製等進行傳播或發佈。



5000R-RT-0819



Aluminum 5000R



HUFCOR, a US-based corporation, is the global market leader in flexible space management, with an internationally acclaimed heritage of over 120 years. We pride ourselves in our ability to maintain the highest possible standards of differentiated services, including total solutions from design, manufacturing and project management to installation and product maintenance.

Aluminum 5000R is an integral part of HUFCOR's product line which is the broadest available from any operable walls manufacturer. A strong, lightweight 6063-T6 architectural aluminum frame surrounds and protects the face of each panel and a 83mm (3 1/4") thick Aluminum 5000R panel means less storage space. Its sophisticated vertical and horizontal seal systems create optimum acoustic separations with STC rating of up to 52. The top-hung Aluminum 5000R panels are available in heights of up to 7.5 meters (24 ft 7 in) without the need for floor tracks or floor guides.

HUFCOR's globally-proven multi-directional trolley systems create the easiest movement through turns and crosses to remote storage. And our quick-setting seal system creates the fastest operable wall setup and storage.

赫福高是一間總部位於美國，擁有逾120年歷史享譽國際的跨國企業。作為靈活空間管理的全球領導者，我們致力於提供各種最高標準的服務，包括設計、生產製造、項目管理、產品安裝以及維修保養的全面解決方案。

Aluminum 5000R是所有活動屏風製造商最為廣泛供應的屏風產品，亦是赫福高產品系列中重要的一環。每片採用高強度的輕質鋁合金邊框(高密度標準建材級別6063-T6，銀白色)作為屏風表面收邊。其僅有83mm的產品厚度意味著儲存空間更小。精密的縱橫密封系統締造出完美的隔音效果(最高可達STC 52)。頂部懸吊式的Aluminum 5000R高度可達7.5米，而無需地面導軌或地面導槽。

赫福高受世界公認的多方向式路軌滑輪系統創造了最為簡易的屏風運行環境，屏風可通過路軌轉向及駁口處迅速進入藏板間。同時，我們的快速設置密封系統使固定與收藏屏風的操作更為便捷。



Features

產品特點

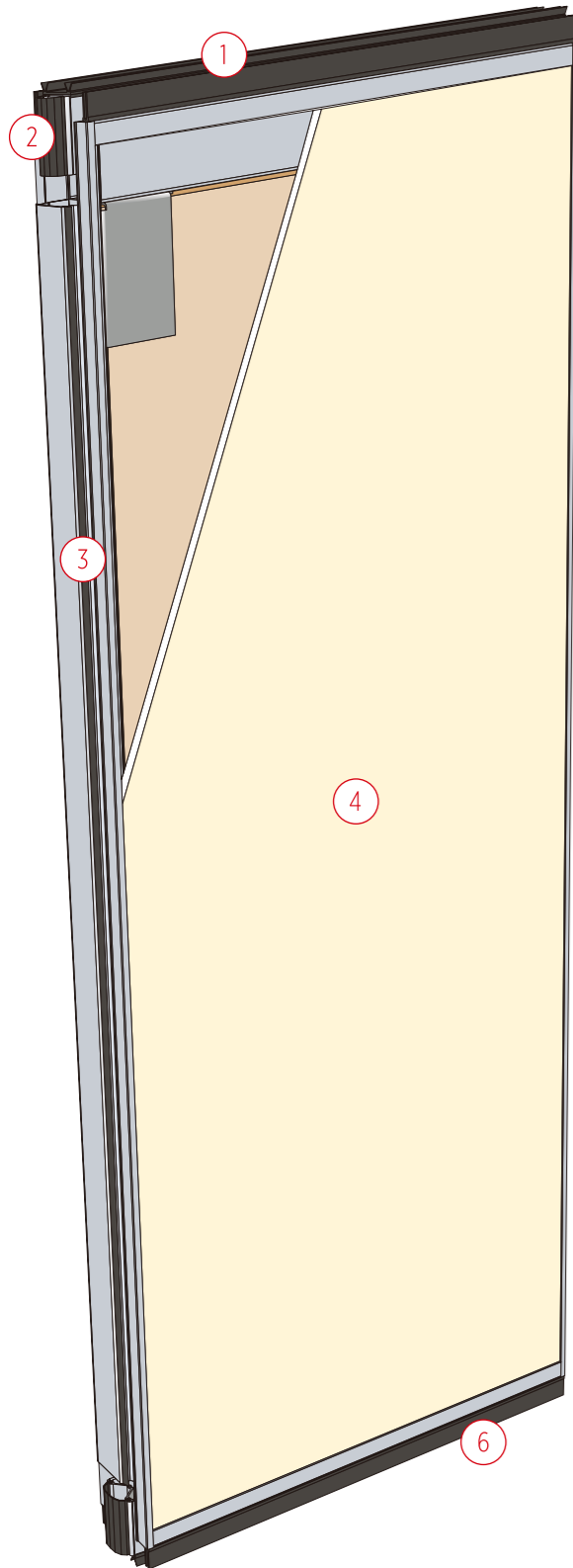

- ① Operable top seal (available on all models) retracts for easy and smooth panel movement.
頂部的水平機械伸縮密封系統方便屏風的移動與固定。
- ② Interlocking vertical seals for superior acoustics.
內部嵌鎖式垂直密封系統確保優良的隔音效果。
- ③ Rigid, reinforced, non-deflection frame.
剛硬有韌性、不易變形的屏風邊框。
- ④ Faces of plywood board, steel or gypsum board that can be factory or field decorated.
屏風可選用木板、鋼板或石膏板為出廠基本完成面或現場安裝飾面。
- ⑤ Laminated construction provides superior panel flatness and high-impact resistance.
多層式完成面結構提供了優越的屏風面板平整度和高耐衝擊性。
- ⑥ Quick-Set™ (no tedious cranking).
快速設置密封操作系統 (無需繁瑣地多次搖動屏風手柄)。
- ⑦ Pressure-type retractable floor seal for superior acoustical performance.
底部的水平機械伸縮壓力密封系統可增強隔音性能。

Aluminum 5000R STC & Hanging Weights

隔音系數及屏風懸吊重量

Omni-Directional Panels Models 多向式屏風型號	Paired Panels Models 單向式屏風型號	Acoustic Ratings 隔音系數 (STC)	Approx. Hanging Weight (kg/m ²) 屏風懸吊重量 (公斤/平方米)
5670R	5570R	52	61.5
5660R	5560R	51	49.8
5650R	5550R	49	43.1
5640R	5540R	47	33.9
5630R	5530R	45	29.5
5610R	5510R	42	27.6
5600R	5500R	40	25.7

Specifications

產品規格

Omni-Directional Panels

多向式屏風

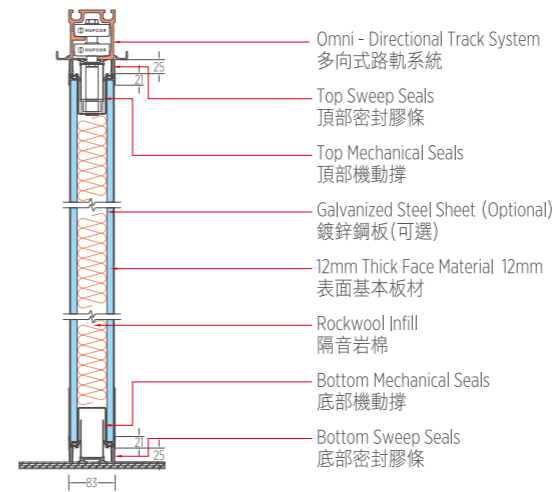

Paired Panels

單向式屏風

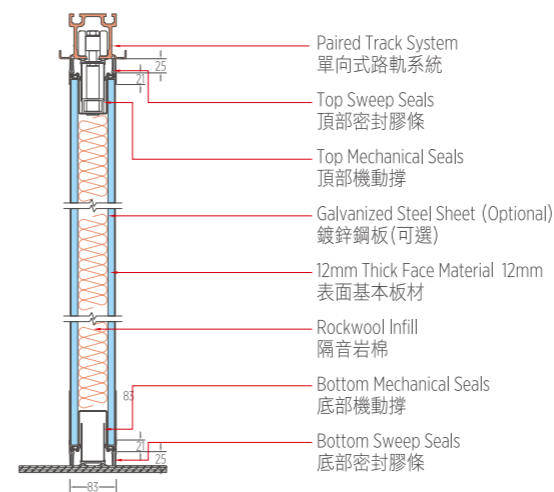

Vertical Section 垂直截面圖

Lever Closure

伸縮板

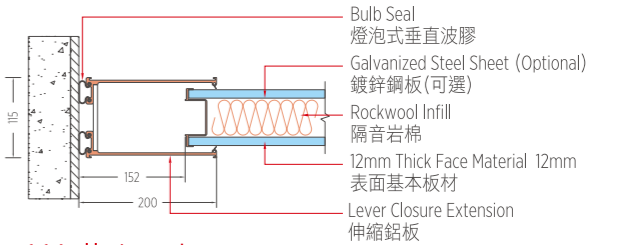

Wall Jamb

隔音門梃

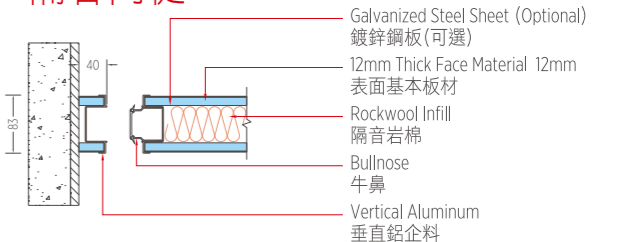

Typical Panel Joint

基本板結點

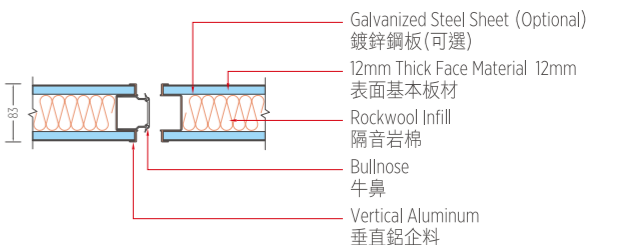

Bulb Seal

波膠板



Horizontal Sections 水平截面圖

STC 52 Laboratory Test Result 實驗室測試結果

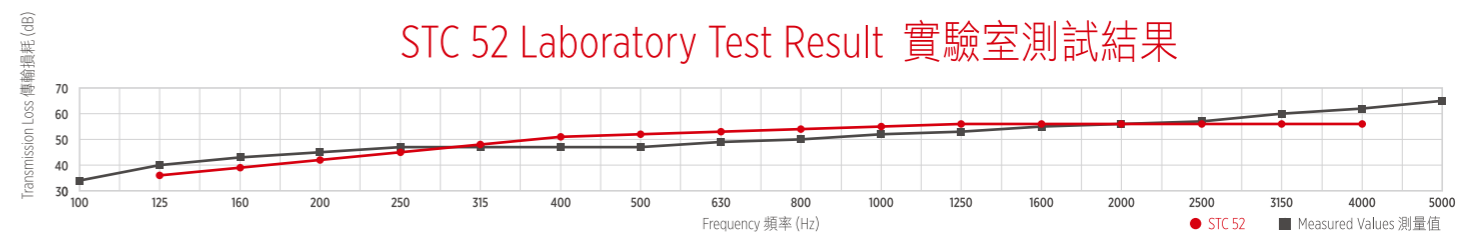

Panel Construction

- Panels are available in 83mm thickness to 1219mm in width.
- Frames are made of clear anodized 6063-T6 architectural aluminum, designed to capture and protect the edges of acoustical faces.
- Acoustical faces are available in not less than 12mm on each side of the panel. They are made of either particle or gypsum board assembled to provide appropriate acoustical performance that meet STC requirements.
- Optional upgrade: Electro-galvanized steel plate laminated to the gypsum board faces are available for extra panel surface protection against rough use and abuse.
- Frames are adaptable to individual or paired panel operations with recessed hinges protruding no more than 25mm (1") from face.

Seals

- Vertical sound seals have 'tongue and groove' interlocking aluminum profile incorporating vinyl acoustical seals.
- Horizontal sound seals between panels and top supporting track are retractable and provide 25mm nominal operating clearance.
- Horizontal sound seals between panels and floor are retractable and provide a range of 25-40mm nominal operating clearance to accommodate normal floor gradient.
- Top and bottom horizontal seals can be operated simultaneously by a removable handle with a single crank action not requiring more than one turn on the spindle shaft.

Finishes

- Unfinished panels ready to accommodate field-applied finishing.
- Vinyl wallpaper, laminates and fabric finishing are available from the manufacturer's standard list of finishes.

屏風構造

- 屏風的標準厚度為83mm，闊度1219mm。
- 屏風框架完全採用經陽極氧化處理的鋁合金(高密度標準建材級別6063-T6，銀白色)製造，其邊框設計能夠固定並保護隔音基本完成面。
- 屏風每邊的隔音基本完成面厚度均不可少於12mm。可選用木板或石膏板與隔音基底層組合來滿足STC隔音需求。
- 可選升級方案：在惡劣環境中使用時，還可選用石膏板表面增加鍍鋅鋼板為基本完成面來提供額外的保護。
- 屏風框架有單片式及雙片式可選，雙片式屏風框架需帶有距離基本完成面不大於25mm的嵌入式鉸鏈。

密封膠條

- 垂密封隔音膠條由舌槽式側邊鋁內嵌隔音封膠條組成。
- 屏風與支撐路軌間的頂部水平隔音封條由機械操作並可提供25mm的常規伸縮空間。
- 屏風與地面間的底部水平隔音封條由機械操作並可提供25-40mm的常規伸縮空間以適應地面的水平高差。
- 屏風頂底部的水平隔音封條均可通過180°旋轉操作活動手柄來同時打開固定而無需多次重複地搖動手柄。

完成飾面

- 屏風可以半完成面的形式到達現場進行裝飾面加工。
- 屏風的標準完成面除石膏板、木板及鋼板面外，也可選擇牆紙、牆布、防火板或其他客戶所需的完成面。

Suspension System

- Track consists of clear anodized architectural-grade aluminum alloy 6063-T6. Track incorporates alignment pins for positive alignment, is utilized for optimum sound control, and have integral support for adjoining ceiling, soffit, or plenum sound barrier.
- Track intersections must be designed and constructed to enable smooth operation. They are made from the same architectural-grade extruded aluminum similar to the regular track without variation in texture and colour.
- Track carriers are made with precision ground steel ball bearing wheels encased in molded polymer tires to protect the running aluminum track surface.

Partition System

- The lead panel has the option of being fixed into an acoustical wall jamb or complete with balloon vinyl seal without the need of a wall jamb.
- "Final closure" panel comes with an expandable jamb exerting a minimum of 110kg (250lbs) force to tighten the partition for optimum acoustics.
- Single or double inset pass doors of the same panel thickness are also available without the need for protruding door hardware.

Acoustics

- The partition system has been tested by a recognized independent acoustical laboratory according to either ISO 140-3, ASTM E90 or ISO 10140-2 standard for sound ratings.

Warranty

- The partition system purchased and installed by the manufacturer's authorized agents shall be entitled to a warranty of two years against defects in material and workmanship.

懸掛系統

- 路軌系統是由經陽極氧化處理的鋁合金(高密度標準建材級別6063-T6，銀白色)壓制而成並由駁針固定接合調整成直線來確保路軌有一個平穩、靜音操作及最大限度隔音的良好表現。
- 駁口必須與直線路軌一樣由同種鋁合金(高密度標準建材級別6063-T6，銀白色)壓制而成，確保屏風通過駁口時能平穩過渡並有一個材料質地、結構及色彩均無變化的整潔外觀。
- 滑輪軸承內部有精準的水平鋼珠設計，外部有聚合材料的輪套來保護鋁合金路軌的內表面，使屏風運行平滑、安靜、順暢。

屏風系統

- 波膠板或隔音牆壁門挺裝置可使首片屏風與固定牆體密合。
- 末片屏風帶有的伸縮板裝置可發揮至少110公斤的密封壓力來密合屏風從而實現最佳的隔音效果。
- 同樣厚度的單片或雙片門中門均無外露的緊固配件，同時有完美的門鎖五金可供客戶選擇。

隔音性能

- 屏風系統均通過一家公認的獨立聲學實驗室根據ISO 140-3，ASTM E90 或 ISO 10140-2 的標準進行隔音測試。

質量保證

- 由赫福高或經赫福高生產許可認證的代理商處購買並安裝的屏風系統均享有由工程竣工日起計兩年的保養期(包括產品材料及生產工藝上的缺陷，人為損壞除外)。

Track Systems

軌道系統

A high quality track system ensures that HUF COR partitions will operate smoothly for years to come and assist in the quick set-up and storage of panels. All HUF COR tracks have been rigorously tested for a minimum of 100 miles (161 km), approx. 14 years of usage cycle time. Job requirements vary, which is why HUF COR offers a wide selection of tracks to meet your operating requirements.

我們高品質的軌道系統能確保赫福高屏風順暢運行多年，並能快速地進行屏風的放置與收藏。所有的赫福高屏風路軌都經過嚴格的性能測試，確保屏風至少運行100英里(161公里)，約14年的使用期限。赫福高有多種路軌以供選擇來滿足各種工程需求和您的營運所需，這也是我們的專利設計在行業中被反覆模仿的原因。

Aluminum Track Installation

鋁製路軌安裝方案

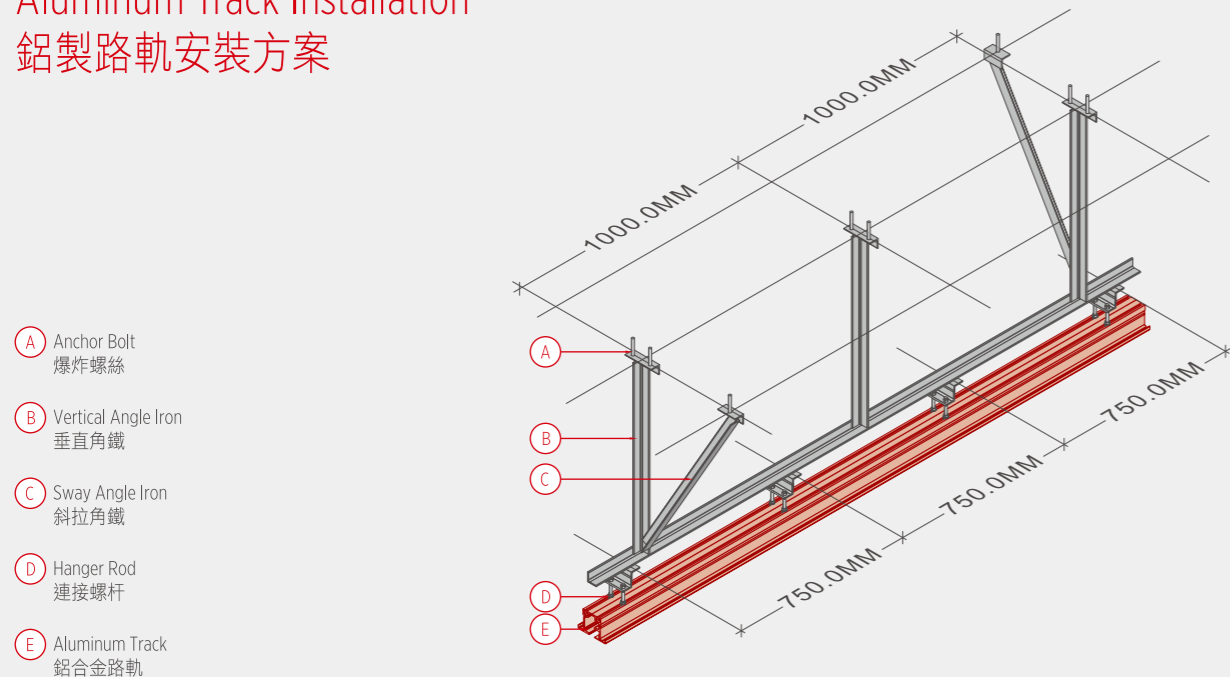

Steel Track Systems

Omni-Directional, Paired and Electrical Panels

HUF COR steel track is used when the partition height or weight limit exceeds that recommended for the aluminum system.

TYPE 11

11型路軌



Weights up to 3000lbs (1364kg) per panel
每片屏風最大懸吊重量可達1364公斤

鋼鐵路軌系統

多向式、單向式及電動屏風

赫福高鋼鐵路軌系統適用於當活動屏風高度或重量超過鋁合金系統可承載極限時。

Aluminum Track Systems

Omni-Directional Panels

Dual wheel trolleys that negotiate 90° turns, through X, L, and T intersections. Two carriers are provided per panel. Each carrier has two horizontal counter-rotating wheels that roll (not slide) in the track. Each wheel has precision-ground bearings, encased with Delrin™ for quiet operation. Carriers easily negotiate square or angled corners without switches.

TYPE 26

26型路軌

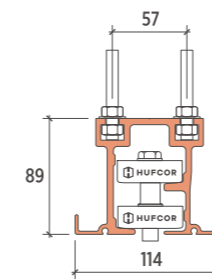

Weights up to 500lbs (227kg) per panel
每片屏風最大懸吊重量可達227公斤

TYPE 36

36型路軌

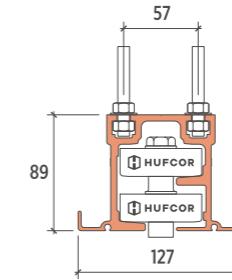

Weights up to 1000lbs (455kg) per panel
每片屏風最大懸吊重量可達455公斤

TYPE 57

57型路軌

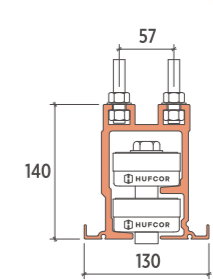

Weights up to 1500lbs (680kg) per panel
每片屏風最大懸吊重量可達680公斤

鋁合金路軌系統

多向式屏風

每片多向式屏風配置的雙滑輪在通過 X型、L型及T型駁口時可90°轉彎。每個滑輪配有兩個水平反向旋轉輪在路軌中轉動(而不是滑動)。每個滑輪都有精密的內部軸承，外部有聚合材料的保護輪套來實現靜音操作。滑輪可順暢地在路軌方形或尖角轉彎處通行而無需開關控制。

Paired Panels

One 4-wheeled carrier is provided per panel. Each wheel is made of molded polymer tires on hardened steel ball bearings.

TYPE 38

38型路軌

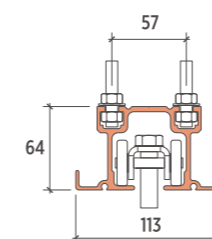

Weights up to 400lbs (182kg) per panel
每片屏風最大懸吊重量可達182公斤

單向式屏風

每片單向式屏風配置一個四輪滑輪。每個滑輪都有精密的內部軸承，外部有聚合材料的保護輪套來實現靜音操作。

TYPE 40

40型路軌

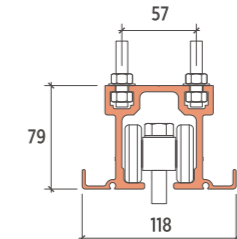

Weights up to 900lbs (408kg) per panel
每片屏風最大懸吊重量可達408公斤

HUF COR's track and carrier system is patented in US
赫福高生產的路軌及滑輪系統已在美國獲專利認證

Resilient mounted body for quiet operation and load distribution
具備安裝彈性的滑輪路軌系統可實現靜音操作以及合理的懸吊重量分配

Operable Partitions Types

活動屏風類型

Omni-Directional Panels 多向式屏風

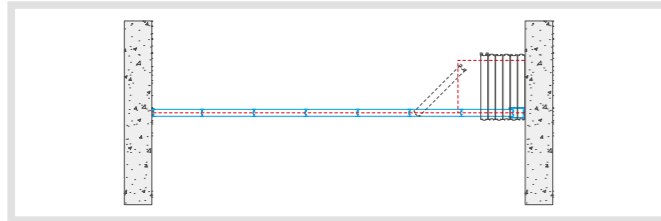

Omni-directional panels provide the ultimate flexibility to your operations because each individual panel can easily turn around corners and move to alternate locations or remote storage. Therefore, many different storage layouts can be created to fit your floor design and layout.

多向式屏風最大程度地體現了空間使用上的靈活性。每片屏風可簡易快速地轉向、以不同角度設置在不同的位置或移動到距離較遠的藏板間，因而可創造出多種藏板間佈局設計。

Paired Panels 單向式屏風

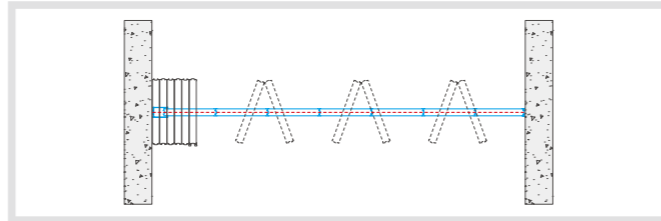

When remote storage is not required, the center-hung panels hinged in groups of two or three, are the ideal solution for quicker and easier set up, than omni-direction panels. Optional hinging is available to accommodate moldings or other decorations. Acoustical ratings are the same as omni-direction Panels.

當無需藏板間時，可選用配置單輪中心懸掛以鉸鏈連接兩片或三片為一組的單向式屏風，相較於多向式屏風而言是一種可快速、簡易設置的理想空間解決方案。選配的鉸鏈可容納邊角線或其他裝飾面。隔音系數與多向式屏風相同。

Storage Layout Options 藏板間佈局設計

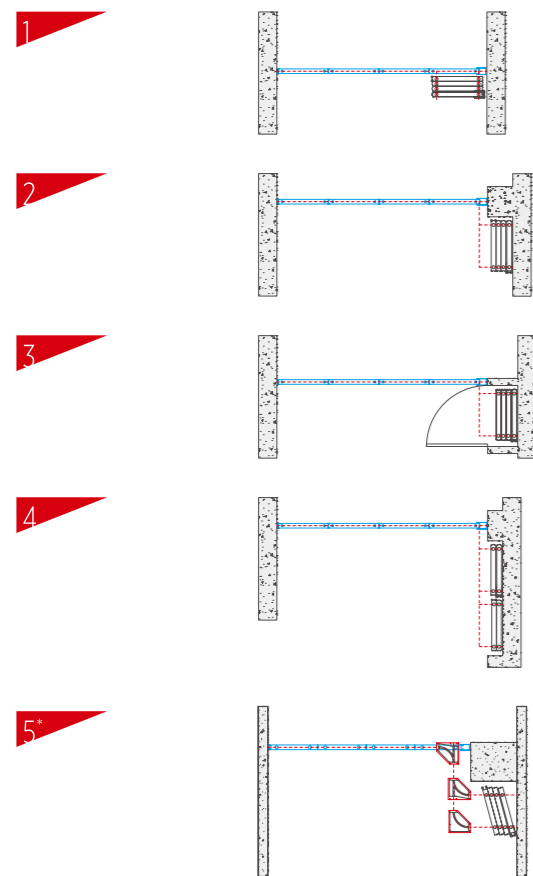

Storage Layout Options 藏板間佈局設計

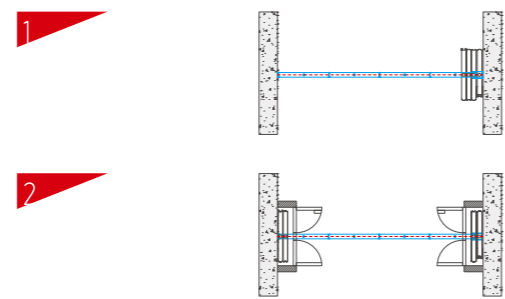

Accessories 配件

A variety of accessories and work surfaces are available to provide the functionality and aesthetics you need.

赫福高有多種屏風配件及工作用途完成面可供選擇來滿足您在功能和美觀上的需要。

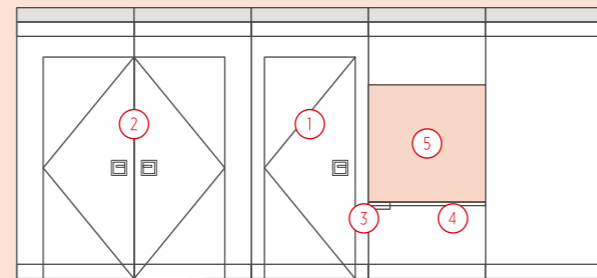

- ① Single Pass Door 單片門中門
- ② Double Pass Door 雙片門中門
- ③ Eraser Pocket 板擦槽
- ④ Recessed Chalk Tray 嵌入式筆槽
- ⑤ Work Surface: Tackboards/Dry Marker Board 釘板/書寫白板

* Type 11 steel track only
只適用於11型路軌

Why HUF COR?

為甚麼選擇赫福高?

Partitions Must Control Sound

We test our products in our sound laboratory to make certain they meet or exceed our published acoustical ratings. The laboratory is certified by the National Voluntary Laboratory Accreditation Program (NVLAP) and, like our ISO certification, we undergo regular inspection to make certain we adhere to their strict regulations.

活動屏風必須隔音

赫福高是中國地區唯一擁有正規聲學測試實驗室的屏風品牌，我們在自己的聲學實驗室測試產品以確保能滿足或超出對外公布的隔音測試系數。我們的聲學測試實驗室是經由「美國國家義務計劃」(NVLAP) 認可的，就像我們的 ISO 證書，是嚴格遵守規定經受定期檢查並通過的。

Renovation and Repair

Not only do we provide new products, we also offer retrofit service for HUF COR products and those manufactured by others. Contact your local HUF COR representative for a free assessment of your needs.

翻新和維修

我們不僅提供新產品，而且對赫福高及其他製造商的屏風產品也提供改裝翻新服務。如果您有需要請與當地的赫福高公司聯繫，我們將為您提供免費的需求分析。

Worldwide Availability

HUF COR's US manufacturing facility is located at our headquarters in Janesville, Wisconsin. HUF COR US, China, Hong Kong, Macau, Malaysia and Taiwan are providing our Aluminum 5000R product in their respective market for flexible space management. In addition to the Aluminum 5000R product, other HUF COR partition lines are also available in Australia, Bangladesh, Brazil, Canada, China, Finland, France, Germany, Hong Kong, India, Indonesia, Japan, South Korea, Mexico, Malaysia, Macau, New Zealand, Philippines, Russia, South Africa, Singapore, Sri Lanka, Spain, Taiwan, Thailand, United Arab Emirates and Vietnam. Check our website for contact details in the respective location.

全球化經營

赫福高總部坐落於美國威斯康辛州的占斯維爾。赫福高美國、中國、香港、澳門、馬來西亞及台灣市場均可提供靈活空間管理的 Aluminum 5000R 活動屏風產品。除 Aluminum 5000R 產品外，赫福高同時向澳洲、孟加拉、巴西、加拿大、中國、芬蘭、法國、德國、香港、印度、印度尼西亞、日本、韓國、馬來西亞、澳門、新西蘭、菲律賓、墨西哥、俄國、南非、新加坡、斯里蘭卡、西班牙、台灣、泰國、阿拉伯聯合酋長國和越南市場提供其他屏風系列產品。赫福高不單是具有百年歷史的活動隔音屏風產品製造商，更是屏風專業品牌中的佼佼者。多年來，一直穩佔全球屏風市場的領導地位，在同業中始終保持領先的優勢。我們的銷售點遍布全球，客戶可瀏覽公司網站選擇赫福高公司或經赫福高授權的經銷商購買產品。

